



# FastLight Pre-inked Stamps

## Size Chart # 0-10

Updated:  
March, 2016



Note: Actual useable area (dotted red border) may be +/- 1 mm (+/- about 3/64") due to slight variations during manufacture such as being off-center or cut slightly short or long. The metric (mm) sizes are more accurate; inch sizes are rounded to nearest 1/8th inch.

**FL0**

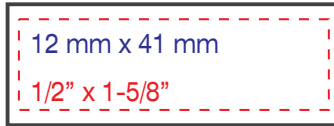

**FL1**

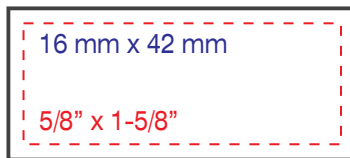

**FL3**



**FL5**



**FL7**



**FL8**

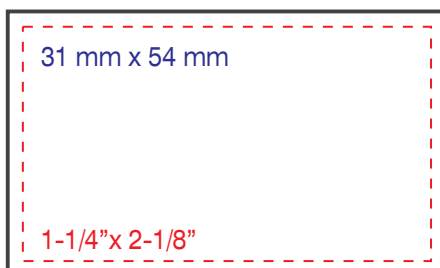

**FL2**



**FL4**



**FL6**



**FL9**



**FL10**

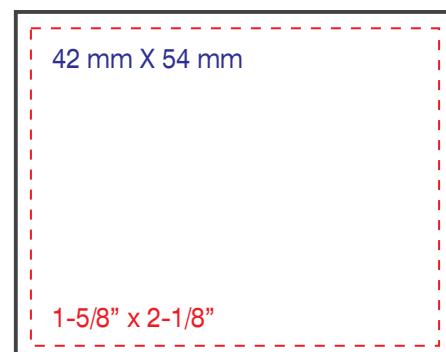



# FastLight Pre-inked Stamps

## Size Chart # 11-16

Updated:  
March, 2016



Note: Actual useable area (dotted red border) may be +/- 1 mm (+/- about 3/64") due to slight variations during manufacture such as being off-center or cut slightly short or long. The metric (mm) sizes are more accurate; inch sizes are rounded to nearest 1/8th inch.

**FL-13**



**FL-12**

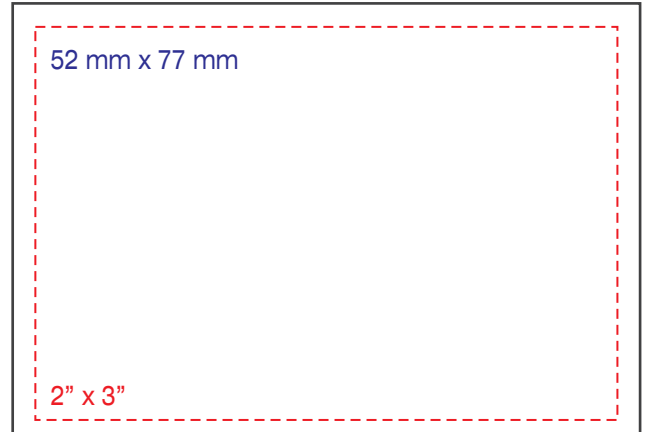

**FL-14**

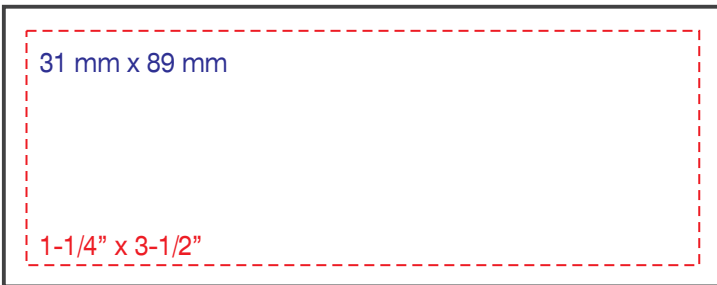

**FL-15**



**FL-11**

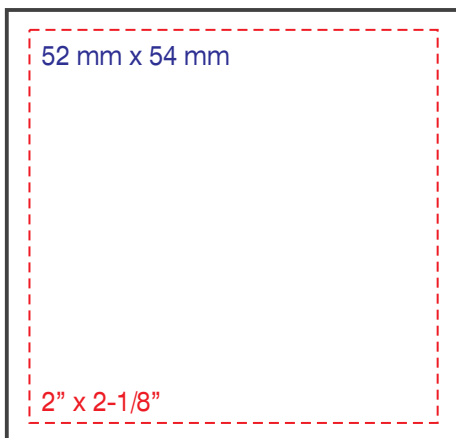

**FL-16**

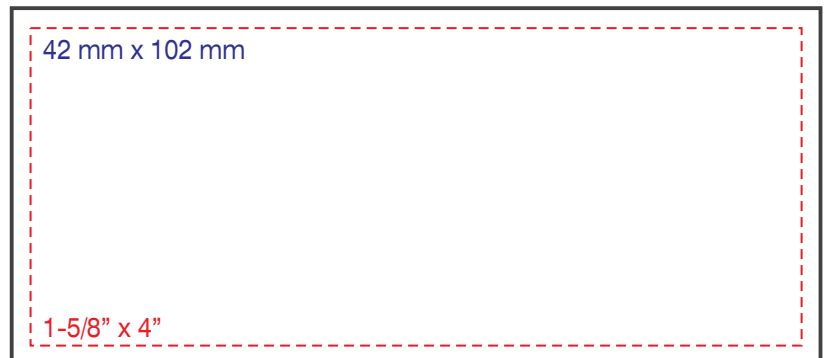



# FastLight Pre-inked Stamps

## Size Chart # 17-24

Updated:  
March, 2016



Note: Actual useable area (dotted red border) may be +/- 1 mm (+/- about 3/64").  
The metric (mm) sizes are more accurate; inch sizes are rounded to nearest 1/8th inch.

**FL-17**

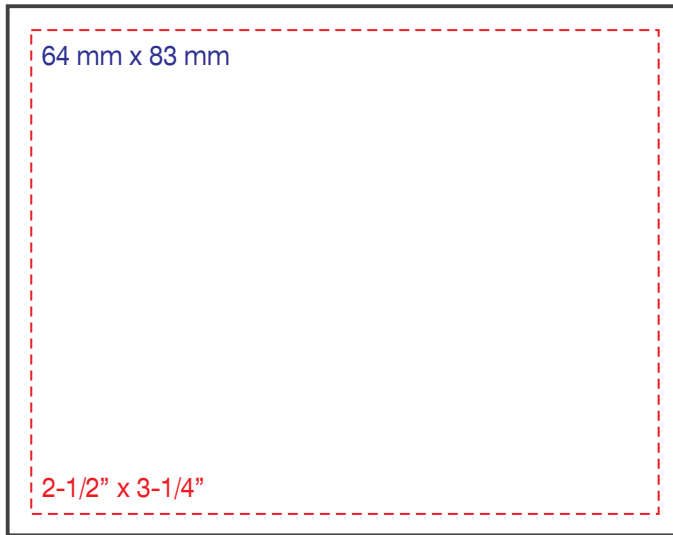

**FL-20**

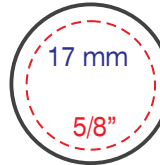

**FL-22**

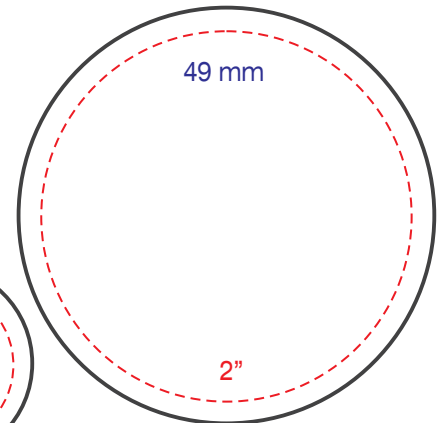

**FL-21**

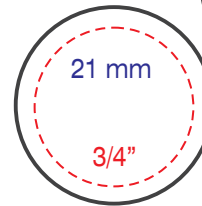

**FL-23**

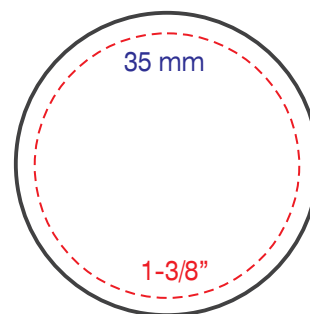

**FL-18**

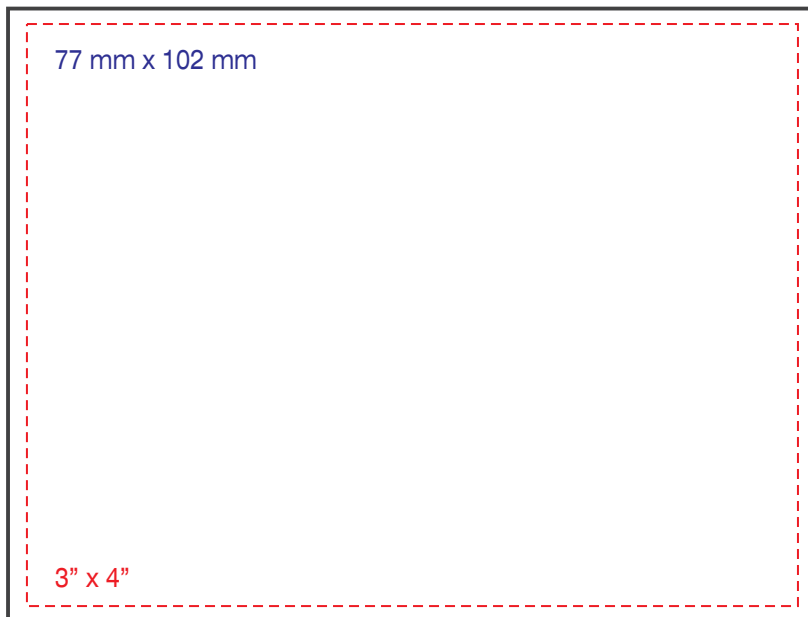

**FL-24**

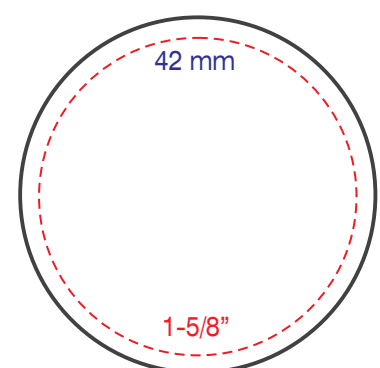



# FastLight Pre-inked Stamps Size Chart # 27-35

Updated:  
March, 2016



Note: Actual useable area (dotted red border) may be +/- 1mm (+/- about 3/64").  
The metric (mm) sizes are more accurate; inch sizes are rounded to nearest 1/8th inch.

**FL27**

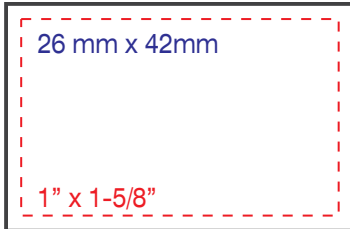

**FL28**

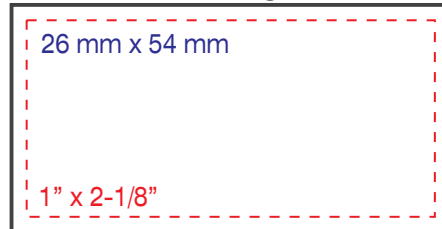

**FL29**

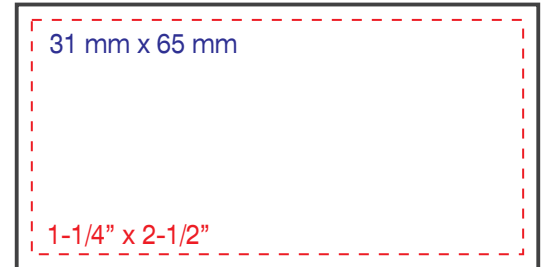

**FL31**

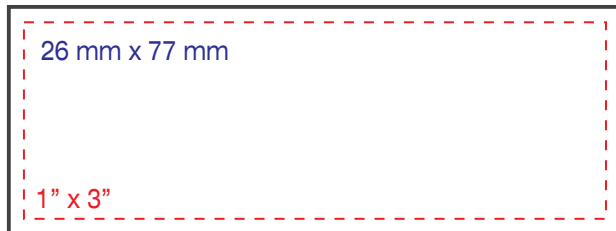

**FL32**



**FL33**

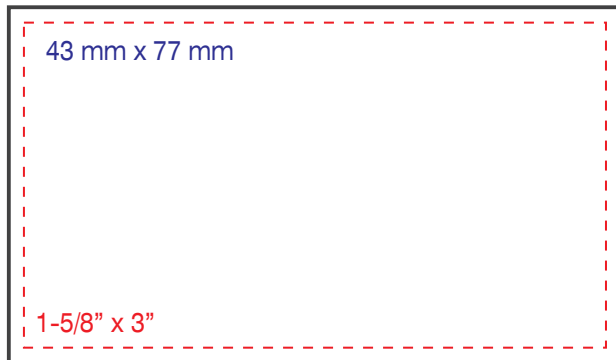

**FL34**

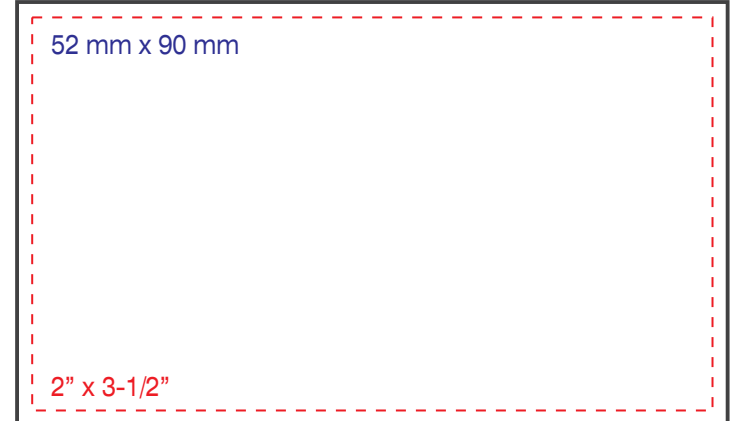

**FL35**

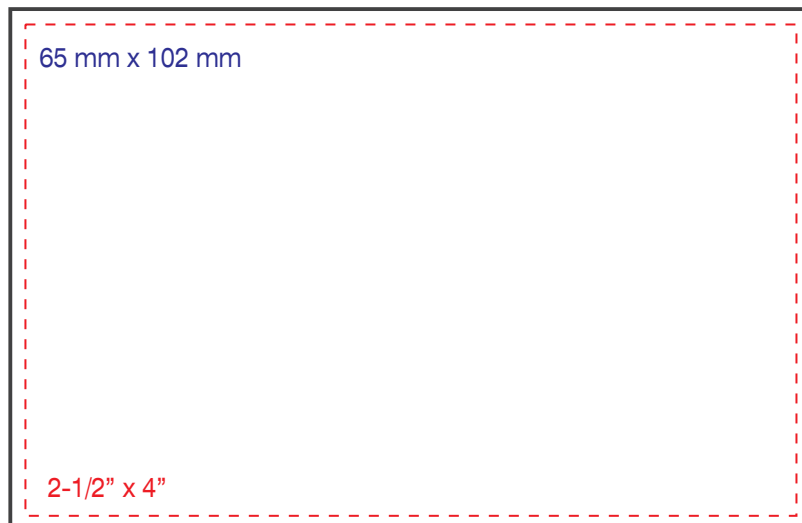

**FL30**

